

SEETRONIC

Product Data Sheet

产品规格书

Product Type
产品类型

XLR Socket
卡侬插座

Product Model
产品型号

SCBDM3-H

Customer Name
客户名称

Manufacturer 生产方	Prepared 制作	Checked 审核	Approved 核准

Customer 客户方	Received 接受	Checked 审核	Confirmed 确认

Above specifications and information may have tolerances and have been updated.
Every effort has been made to ensure correctness upon release of this data sheet.
以上规格和信息可能存在公差，并已更新。我们已尽一切努力确保本规格书发布时的正确性。

All Rights Reserved 2023
保留所有权利 2023



sales@seetronic-group.com
www.seetronic.com

Product Data Sheet 产 品 规 格 书

Product Type 产品类型	XLR Socket 卡侬插座	
Product Model 产品型号	SCBDM3-H	
Product Features 产品特性		
<ul style="list-style-type: none">➤ 3-pin XLR male socket, grounding: separate ground contact to mating connector shell and front panel, horizontal PCB mount➤ Plastic housing, steel latch lock, gold plated contacts➤ Small size and high packing density (23 mm between centers)➤ Install from the rear of the panel ➤ 3 芯 XLR 公座，接地方式：与外壳及前面板相连的独立接地脚，水平 PCB 安装面板➤ 塑料面板，钢制门锁，接触点镀金➤ 小尺寸、安装堆积密度高的 XLR 插座(中心距离 23mm)➤ 内装,美观经济		



Product Data Sheet 产品规格书

Product parameters 产品参数

Item 项目	Specification 规格
Connection Type 连接类型	XLR 卡侬
Gender 公母性	Male 公座

Electrical Parameters 电气参数

Item 项目	Specification 规格
Capacitance between contacts 触点间电容	$\leq 4 \text{ pF}$
Contact resistance 接触电阻	$\leq 6 \text{ m}\Omega$
Dielectric strength 介电强度	1500V DC
Insulation resistance 绝缘电阻	$> 10 \text{ G}\Omega$ (initial)
Rated current per contact 每触点间额定电流	6 A
Rated voltage 额定电压	$< 50 \text{ V}$



Product Data Sheet 产品规格书

Mechanical Parameters 机械参数

Item 项目	Specification 规格
Insertion force 插入力	≤ 20 N
Withdrawal force 拔出力	≤ 20 N
Service life 使用寿命	> 1000 mating cycles > 1000 次使用周期
Locking wiring 锁定方式	Latch lock 按键制锁
PCB Wiring 相对 PCB 安装方式	Horizontal PCB mount 水平安装 PCB

Material and Environmental Parameters 材料和环境

Item 项目	Specification 规格
Contacts 触点	Cu alloy 铜合金
Contact plating 触点电镀	Au 金
Housing 外壳	PA 尼龙
Flame-retardant grade 阻燃等级	UL94V-0
Temperature range 使用温度范围	-30°C ~ +80°C

Standards and Certifications 标准和认证

Solderability 可焊性	IEC 68-2-20
----------------------	-------------



Product Data Sheet 产品规格书

Product Drawing 产品外形尺寸

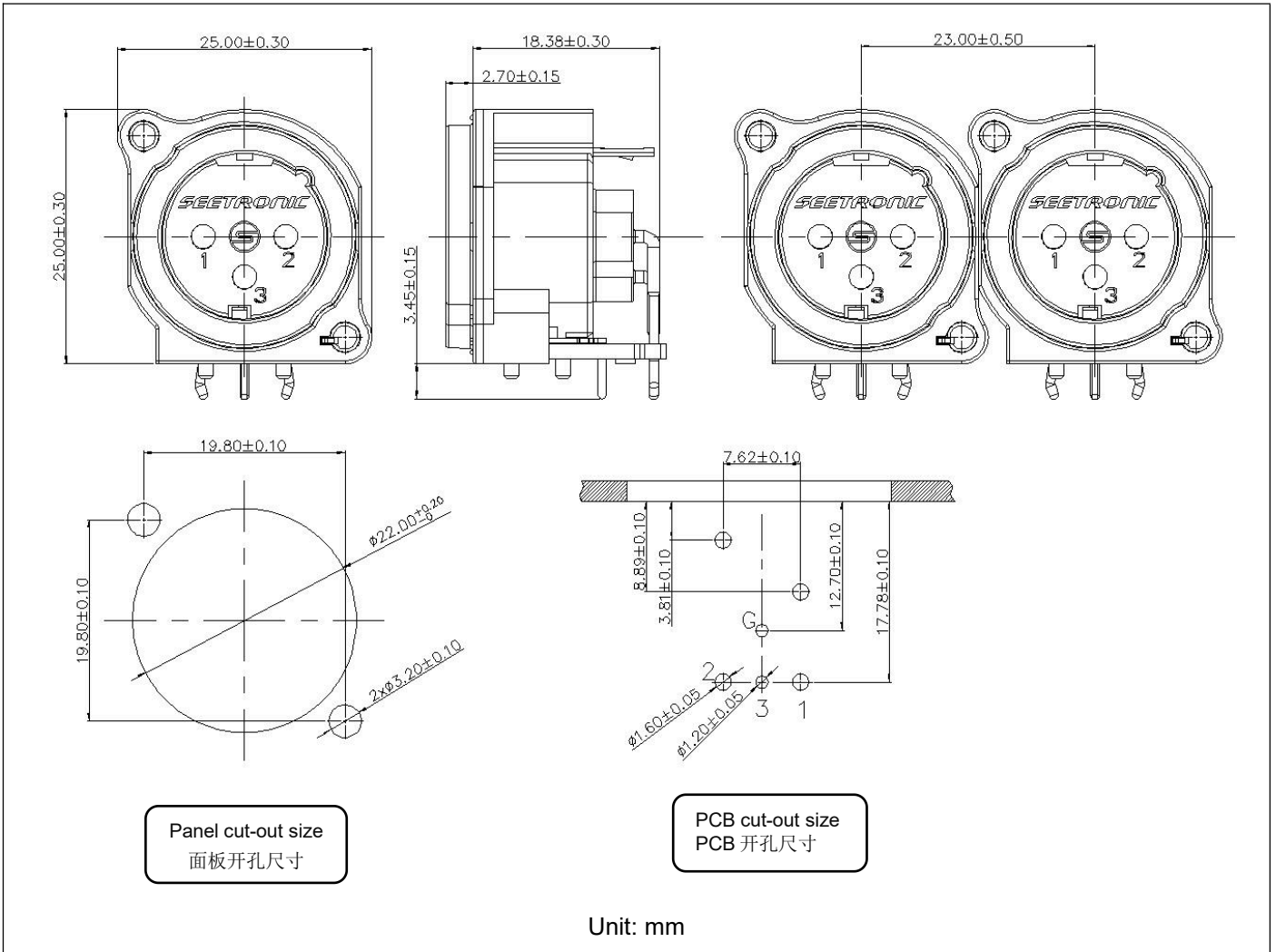

Packaging Method 包装方式

Blister box packing

20pcs per blister box, 120pcs per inner carton, 5 inner cartons per master carton (600pcs per master carton)

吸塑盒包装

20个/吸塑盒, 120个/内盒, 5个内盒/箱(即600个/箱)



Product Data Sheet 产品规格书

Accessory 配件

- | | |
|---|---|
| <input checked="" type="checkbox"/> No accessories
无配件 | <input type="checkbox"/> Back fastener plate
安装固定件 |
| <input type="checkbox"/> Screws and Nuts
螺丝和螺帽 | <input type="checkbox"/> Other
其他 |

Assembly Instructions 安装使用说明

Install the socket on the back of the panel and tighten the screws with 0.45 Nm torque in a clockwise direction.

(Note: Maximum panel thickness 3.0mm)

将插座后装在箱体开孔处，最后将螺丝按顺时针方向用 0.45 Nm 扭矩拧紧。

(注：面板最大厚度 3.0mm)

