

SEETRONIC

Product Data Sheet

产 品 规 格 书

Product Type
产品类型

IP65 RJ45 Plug
防水 RJ45 插头

Product Model
产品型号

SE8MC-05-B-01-NEW

Customer Name
客户名称

Manufacturer 生产方	Prepared 制作	Checked 审核	Approved 核准
	杨振宇 11.18	张信松 25.11.18	张永平 25.11.17

Customer 客户方	Received 接受	Checked 审核	Confirmed 确认

Above specifications and information may have tolerances and have been updated.
Every effort has been made to ensure correctness upon release of this data sheet.
以上规格和信息可能存在公差，并已更新。我们已尽一切努力确保本规格书发布时的正确性。

All Rights Reserved 2023
保留所有权利 2023



sales@seetronic-group.com
www.seetronic.com

Product Data Sheet 产 品 规 格 书

Product Type 产品类型	IP65 RJ45 Plug IP65 RJ45 插头	
Product Model 产品型号	SE8MC-05-B-01- NEW	

Product Features 产品特性

- This waterproof RJ45 system is an upgraded version of SE8MC-02-NEW with a waterproof rating of IP65
 - RJ45 cable carrier connector with chrome housing
 - This RJ45 plug can only be used with our 05 series connectors, not compatible with other RJ45 connector
 - Cable connector carrier does not include RJ45 plug
 - Cable O.D. 5-7mm
 - Exceptionally quick plugging and unplugging with one-hand operation which saves time compared to traditional waterproof RJ45 cable connectors in the market
 - Push button lock is designed on the plug with a sturdy spring inside. Even if the spring breaks, it can be unlocked which is more stable than traditional signal connectors in the market
 - Sturdy die-cast housing and unique cable clamp
 - Sleek design protects Ethernet connections in most commercial type applications and components of standard RJ45 plugs
-
- 这款防水 RJ45 系统是 SE8MC-02-NEW 的升级款，防水等级 IP65
 - RJ45 电缆连接器，外壳镀铬
 - 该 RJ45 插头只能与我们的 05 系列连接器一起使用，不能与其他 RJ45 连接器兼容
 - 电缆护套不包括水晶头
 - 线径范围：5-7mm
 - 真正实现快速插拔，单手操作，一个动作即可解锁，相比市面上传统的防水信号产品节约时间
 - 将锁设计在插头上，内部设计一个坚固的弹簧，按下按键解锁，即使弹簧失效也可以解锁，比市面上的传统信号产品更加稳定
 - 坚固的压铸外壳和独特的线夹锁卡
 - 时尚的设计，在众多商业应用中，保护以太网连接，并保护 RJ45 标准接插件中的组件



Product Data Sheet 产品规格书

Product Parameters 产品参数

Item 项目	Specification 规格
Connection Type 连接类型	RJ45
Gender 公母性	Male 公

Mechanical Parameters 机械参数

Item 项目	Specification 规格
Cable O.D. 线缆线径	5-7mm
Insertion force 插入力	≤ 40 N
Withdrawal force 拔出力	≤ 40 N
Service life 使用寿命	> 1000 mating cycles > 1000 次使用周期
Locking device 锁定装置	Latch lock 按键锁定



Product Data Sheet 产品规格书

Material and Environmental Parameters 材料和环境

Item 项目	Specification 规格
Boot 尾套	PA 尼龙
Housing 外壳	Zinc alloy 锌合金
Housing plating 外壳电镀	Black coating 镀黑
Push button 按键	Zinc alloy 锌合金
Protection degree 防护等级	IP65
Temperature range 使用温度范围	-30°C ~ +80°C

Product Drawing 产品外形尺寸

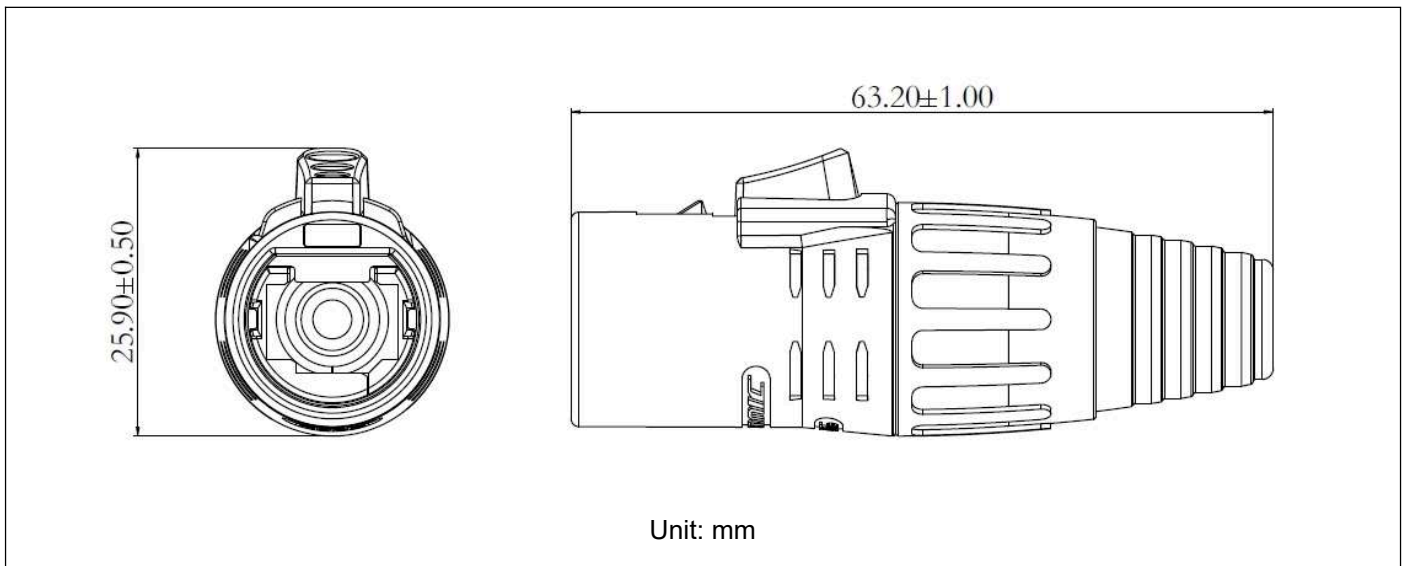

Product Data Sheet 产品规格书

Packaging Method 包装方式

1pc per bag (including 1pc each of housing, cable clamp and boot)
80pcs per inner carton, 5 inner cartons per master carton (400 pcs per master carton)

1 个/袋 (包含外壳、线夹、尾套各 1 个)
80 个/内盒, 5 个内盒/箱 (即 400 个/箱)

Accessory 配件

- | | |
|---|---|
| <input checked="" type="checkbox"/> No accessories
无配件 | <input type="checkbox"/> Back fastener plate
安装固定件 |
| <input type="checkbox"/> Screws and Nuts
螺丝和螺帽 | <input type="checkbox"/> Other
其他 |



Product Data Sheet 产 品 规 格 书

Assembly Instructions 安装使用说明

- (1) Thread the cable through the boot and the waterproof cable clamp.
将线缆穿过尾套与防水线夹

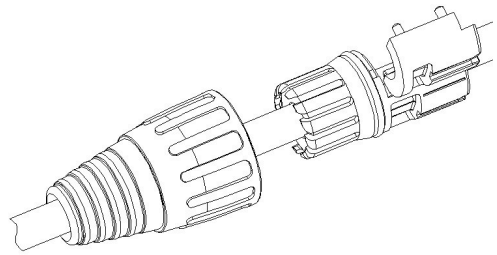

- (2) Assemble the cable with RJ45
组装水晶头

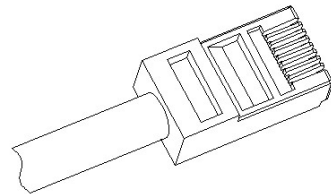

Product Data Sheet 产品规格书

(3) Put the RJ45 into the cable clamp and fasten the cable clip

将水晶头装入线夹内，并扣上线夹

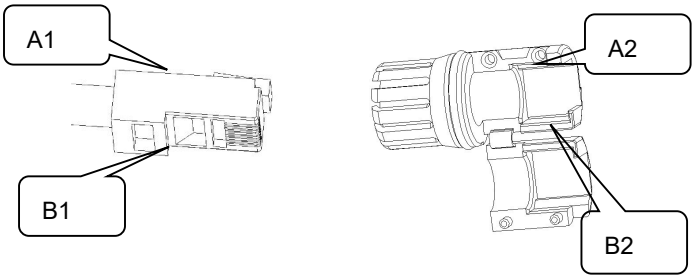

①水晶头 A1 面、B1 面分别与线夹 A2 面、B2 面对应
The A1 and B1 sides of the RJ45 correspond to the A2 and B2 sides of the cable clip respectively.

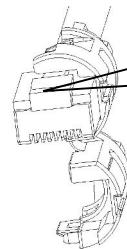

②水晶头压片按入线夹挡块内
RJ45 sheathing presses into cable clip block

③扣合线夹
Close the cable clamp

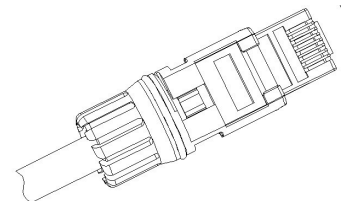
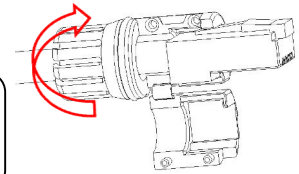

Product Data Sheet

产 品 规 格 书

- (4) Push the assembled cable clamp and RJ45 into the housing

将组装后的线夹与水晶头推入外壳内

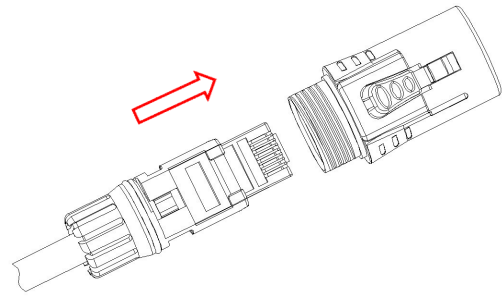

- (5) After assembly of the cable clamp, RJ45 and housing, tighten the boot in a clockwise direction

线夹、水晶头与外壳装配后，将尾套按顺时针方向拧紧

